

3-core straight-through joint

for armoured 3-core polymeric cables up to 7.2 kV

Suitable for armoured 3-core polymeric insulated cables (PVC, PE, XLPE, EPR) without an outer semi-conductive layer. They allow the connection of cables with different cross sections and conductor materials even with different cable design. They do not contain any substances which inhibit paint wetting and are suitable for use in the automotive industry. With hydrolysis resistance PUR cast resin EG. Suitable for compression connectors.



Product description

Article name	M4 MS6
Article number	124318
Notes	REACH Regulation on the restriction of diisocyanates (for EU countries only)The European Commission amended Annex XVII of the REACH Regulation (EC) (new number 74) with Regulation (EU) 2020/1149, which entered into force on 24 August 2020. In accordance with the new REACH Regulation, appropriate training will be required prior to the industrial or professional use of diisocyanates, adhesives and sealants as of 24 August 2023. All information regarding training materials and training courses is available on the ISOPA/ALIPA website https://www.safeusediisocyanates.eu/
Optional accessory	Connectors (see Connecting technology)

Characteristics

Resistant to chemical agents
 Longitudinally and transversely watertight
 High mechanical strength
 Quick, safe and easy assembly

Applications

Indoor
 Outdoor
 Underground
 Water
 Installation ducts

Technical data

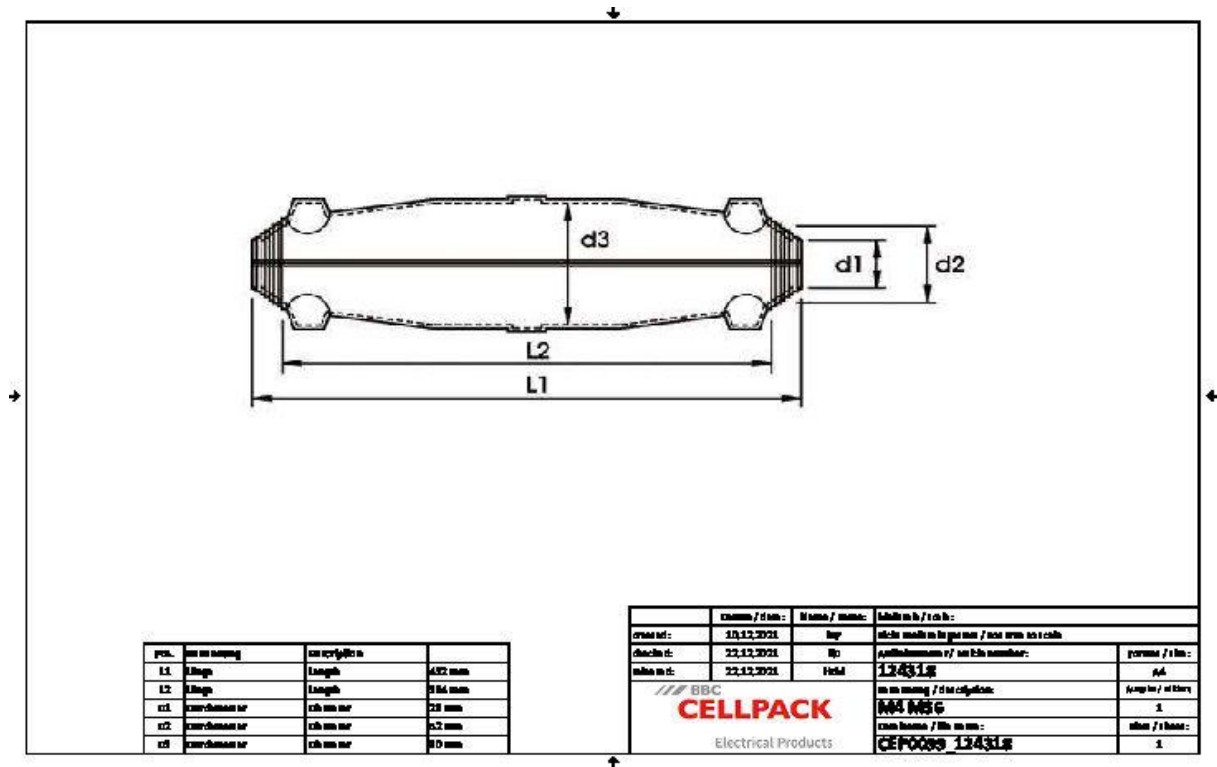

Article name	M4 MS6
Article number	124318
Voltage levels	U0/U (Um) 3,6/6 (7,2) kV - 3,8/6,6 (7,2) kV
Length L1	432 mm
Length L2	384 mm
Diameter D1	29 mm
Diameter D2	52 mm
Diameter D3	90 mm
Nominal cross section Polymeric cable armoured with concentric conductor min	25 mm ²
Nominal cross section Polymeric cable armoured with concentric conductor max	50 mm ²
Nominal cross section Polymeric cable armoured min	25 mm ²
Nominal cross section Polymeric cable armoured max	70 mm ²
Diameter cable min	29 mm
Diameter cable max	55 mm

Logistics data

Article name	M4 MS6
Article number	124318
Delivery scope	Spacer sleeve
	Hydrolysis resistance PUR cast resin EG
	Packed in practical and easy-to-use two-chamber bags
	Transparent plastic shell
	Copper braid tube
	Fill and air-release funnel
	PVC insulation tape
	Protective gloves
	Assembly instructions
Shelf life	40 Month
Country of origin	Germany
Customs tariff number	39095090
EAN/GTIN	4010311002804

Packaging data

Alternative unit of measure	Carton	Pal. OW
Base quantity	1	30
Base unit of measure	Piece	Piece
Length (mm)	488	1200
Width (mm)	248	800
Height (mm)	195	1130
Net weight (kg)	3.458	103.74
Gross weight (kg)	3.458	121.94